

QSOX PE



**THIS NEWSLETTER IS PUBLISHED BY THE
PORT ELIZABETH AMATEUR RADIO SOCIETY**

**PO BOX 10402
LINTON GRANGE
6015**

JUNE 2003

MONTHLY GENERAL MEETING

The monthly general meeting of the PORT ELIZABETH AMATEUR RADIO SOCIETY will be held on Thursday, 19 June 2003 at **the St Hugh's Church Hall, Newton Park**, starting at 20:00 (8 pm).

We can say with certainty that OM Bill ZS2ABZ has got Ken Tremeer, ZS2BWB, to speak to us about WSJT and follow up the recent Intecnet discussion on this interesting development for the VHF/UHF bands.

The usual *bring and buy* sale for various items, for which a table is provided, will be available. To defray the tea, coffee and biscuits there will be a raffle, the tickets going at R2 each. The winner gets a half of the takings, and the rest goes to the Club.

Tea, coffee and stuff for the innards will be provided.

Wrinkly Ravers

The June Rave was attended by 14 bods and bodesses, who made use of the facilities at Saddles, overlooking the beach and sea at Summerstrand. This is now our regular haunt for the Rave, with the occasional nip off to some other place as the need arises.

Come join us at Saddles on **3 July**. The spot is in the Retief Plein shopping centre, Summerstrand, opposite Something Good. 

SA RADIO LEAGUE

As previously mentioned, no decision was taken on the proposed budget for the coming year of the League. Instead, there have been several meetings around the country at which ideas were thrashed out and they have been submitted to Headquarters

It seems that some of them sought the resignation of the President and the financial committee, and as a result the President, OM Syd Tyler ZS6AYC, has resigned. We do not know of others, but the motion actually needs to be approved at a special general meeting in order to take effect.

In the mean time, Hans Potgieter has taken over the reigns, which does not sound a good idea because of his past

attitude relating to how the League's funds need to be spent.

A special general meeting will take place in Johannesburg on 21 June, at which all proposals will, we expect, be finalized.

Our past chairman, Beavan Gwilt, will be in Johannesburg at the time and may *or may not* be able to attend the meeting. He does not, therefore, want proxies.

We would be glad if you could fill in the proxy form enclosed and send it to Richard Seddon, ZS2CLI, in East London. He has played a very substantial part in the League's budgetary affairs and we can support him without any doubt. 



from *The* *Chairman*

With the 2002/3 year now behind us, we can look forward to even better things for the forthcoming year. Many thanks to our outgoing chairman Beavan ZS2RL, and committee members Cyril ZR2H and Garth ZS2HB. Garth, (for his past sins) will of course still be handling the publication of QSX.

The AGM was well attended, with almost seventy members and their families being present. While the weather was far from ideal, the Uitenhage contingent still managed to ensure that braai fires were lit, and for those of us with carnivorous tendencies, much meat was consumed and stories swapped around the two braai drums.

Technology has been the buzz-word for the past few years, and many of the problems being experienced in attracting new members to our clubs and hobby in general are being blamed on the popularity of the Internet. Over the past few weeks, thanks to the efforts of the Border Radio Club, we have been exposed to Echolink – and what may well be the perfect cross-pollination between computers and amateur radio. While to the purists amongst us, this may not seem like ham radio, please remember that technical innovations are what have kept our hobby alive for almost a century. Echolink is breathing life back into an often under-utilised radio spectrum. It makes for interesting listening to hear stations from all around the world chatting on our local repeaters.

Amateur radio in South Africa needs the participation of the youth, and we can reverse the trend by each and every one of us playing just a small part – invite a youngster to one of our meetings, show them around your shack. The SARL Kids Day on June 16th could be an ideal opportunity. Make it happen. By simply making the effort to attend club meetings, you are making a vital contribution. Synergy can make an impossible task surmountable.

We also need to identify opportunities amongst the previously disadvantaged communities. I have had several conversations with Michael Makraka on the subject, and he is already approaching school masters in the townships, in the hope that under their guidance, radio clubs can be formed. Should you have any ideas on the subject, please share them with us.

Finally, to those who wrote the recent RAE and passed, congratulations. We look forward to hearing you on the air – and if you need assistance in setting up a station, what better place to look for advice than at the next club meeting.

Last month I asked members to contact me with regard to portable operation and a possible get-together to discuss or demonstrate various aspects of this. To date I have not had a single person showing interest. Is this because no-one is interested, or is it that they think they know it all?

Remember Murphy's Law that states "Nothing is ever as simple as it seems."

With the Volkswagen rally on our doorstep, and assuming that you intend assisting with communications, this is a good time to check your portable equipment. Make sure that it is functioning properly and that it is capable of providing the communications that you require of it.

While you are at it, considerer backup equipment. Make up a list of items you need to take with, whether it be for the

rally, emergency or other event. Items such as something to drink, food, clothes, spare tools, pille en brille especially for the old-timers, etc. A simple first-aid kit may come in handy.

This monthly contribution to QSX is for your benefit, so it will assist me to make this as beneficial as possible if you contact me with any queries or suggestions with regard to emergency operations.

Also, pass on reports of any emergency situations you may have experienced or been involved with so that it can be shared with other members.

73

**AI ZS2U,
Provincial Director
Hamnet/ECARES**

Ancestors – answer to May condundrum – AI Akers ZS2U

The answer could be calculated arithmetically, but is rather a tedious process. The maths boffins would no doubt recognise this as a geometric progression where:

$$S_n = a (r^n - 1) / r - 1$$

where S_n is the sum of all the terms (number of ancestors)

a = the first term (2, mother and father)

r = the ratio of one term to the next (2. Each step back doubles the number of ancestors for that step)

n = the number of steps (9. Number of generations)

Thus we have:

$$\begin{aligned} S_n &= 2 \times (2^9 - 1) / 2 - 1 \\ &= 1022 \text{ ancestors.} \end{aligned}$$

It is good to think that it took so many people so long to make you. Let's hope that they would have been satisfied with the result!

FOR \$ALE ★ WANTED ★ SWOP

WANTED

* Books on early radio shortwave receivers, past and present, by F. Osterman; Hallicrafters models C.DACHIS, Communication receivers of the Vacuum Tube era by R.S. MOORE — Dudley Forsyth ZS2AW, tel. 046 622 3985

REPORT ON SPECIAL BUDGET MEETING BY CLUBS

On 17 May a Special Budget Meeting was held by club representatives at the NARC in Johannesburg. Hans Potgieter ZS6ALJ as acting President stepped in to chair the meeting. Six Councillors were present, and a total of ten clubs from Division 6 were represented at this meeting.

The meeting had input from the Cape Town meeting; input from a meeting held in Natal; as well as a proposed budget together with notes and proposals from East London.

Although the meeting was intended only to discuss the proposed new budget, discussions covered a wide range of issues.

The Treasurer, Bill ZS5KD, presented a draft budget based on a reduced ordinary fee of R300 pa. After a detailed discussion of individual budget items, it was recognized that the ordinary membership fee could not be set too low if the current activities of the League were to be properly financed. It was considered that the figure of R250 pa proposed by the Cape Town group was too low, as this would be much the same as the previous year's fees in real terms, and would not provide for any reduction of the accumulated deficit.

The figure of R275 proposed by East London could be made to work but would also restrict the operation of the League. The originally proposed fee of R330 pa was definitely too high, and would result in a substantial backlash from members. Similarly, the fee presented of R300 was considered too high, and would result in the loss of too many members.

After much discussion, the members present agreed to recommend a subscription rate of R285 pa for ordinary members and affiliated clubs, and R60 for family members. It was further recommended that the gap between ordinary membership and senior / pensioner membership be eliminated, as the costs associated with providing services were identical.

It was recognized that this would have a negative effect on some retired members, and it was suggested that clubs could subsidise deserving cases. There is also provision for the SARL to subsidise these fees on an individual basis.

The final recommendations by this meeting

to the SGM are as follows:

1. That annual subscription fees be set as follows:
 - 1.2 Family members – R60;
 - 1.3 Overseas members – R600.
2. The Treasurer is tasked to develop a budget based on the proposed fees, using a maximum membership of 1 150 and with the requirement that a minimum of 35% of the total deficit at the end of this financial year be liquidated. Costs would therefore have to be adjusted to achieve that result.
3. Council should pay serious attention to control of expenditure to ensure that cost overruns such as that experienced over the last year do not recur.
4. Council should ensure that expenditure during the early part of the new financial year is restricted on a conservative basis until membership numbers for the year have materialized and are understood.
5. The treasurer should provide summary reports of membership, income and expenditure, preferably on a monthly basis.
6. All members present and participating in this recommendation should publicly support it within their clubs, and attempt to provide explanations where these are required.
7. It was recognized that the setting of subscription fees and the budget was only part of the whole picture. There was a real concern that members do not feel they are obtaining value for money from their membership. It was clear that work needed to be done to solve this more basic problem in the future.

Remember, the Special General Meeting at which the new budget must be presented, discussed, amended and accepted, has been convened for 21 June at the NARC. 

COMPARING SARL SUBSCRIPTIONS

From Roger Davis, ZS1J

Whilst looking through some old Radio ZS's the other day, I found a 1969 issue in which the subscriptions for membership of the SARL were listed. I was amazed to see that the ordinary annual membership fee was shown at R4.75c for the year.

In 1969, I was earning the sum of R300 per month, so I worked out that the annual subs to the SARL were approximately 1,5 % of a monthly salary.

I have no idea what monthly salaries are like in this day and age, but in this area of Plettenberg Bay, not many youngsters earn over R3 000 a month. But let us say a youngster starting out in commerce in Port Elizabeth, as I was in 1969, is earning say R5000 a month. Based on the 1969 percentage, he or she should be paying annual subs to the SARL of R75 a year.

One thing that must be remembered is that in 1969 and right up to the time that the League was moved from Cape Town up to Gauteng, the people who ran the League did so for the love of the hobby and felt it an honour and a privilege to give freely of their time to the amateur fraternity. Unfortunately, this is not so today.

What is needed is for the League either to be disbanded or for a new organisation to offer membership at a realistic level of, say, R100 per annum, and reinstitute the branch system with the new Radio Society. The branch system worked and it worked well.

I would also go as far as to say that once a new organisation comes into

being, without perks and salaries, that membership of the Radio Society of South Africa becomes compulsory for all amateurs. Once this happens, subs could be dropped to the R75 per member level giving the new Society an income of plus minus R375 000. Here's hoping.

[I cannot remember subs being as low as R4,75 a year. Are you sure it was for annual membership, Rog? Something like R16 seems correct at that time.

When the League was in Cape Town, all councillors resided close by. Many worked in Cape Town and some were able to go to the SARL office, which was right in town, during lunch or after work and do their bit. There was a paid office lady, but several members volunteered their time too.

*Radio ZS was done without any editorial cost, and we enjoyed **twelve** copies every year. The QSL Bureau also operated without loss. While most of our current councillors work on a volunteer basis, some are paid at least for some of their work.*

One of our major problems was the imprudent attempt to take over the functions from ICASA. Everything we do on ICASAs behalf is done at great cost, either to the League or to the applicant. No wonder newcomers find there is not enough cash left to join the League, while the considerably enhanced subscriptions deter many older ones in this day and age.

As far as compulsory membership is concerned, I would object. The radio society must make me want to be part of it so that we will all volunteer to join. – Ed.] 

**MINUTES OF THE MONTHLY MEETING OF THE PORT ELIZABETH
AMATEUR RADIO SOCIETY HELD AT St HUGHES CHURCH HALL, NEWTON
PARK, PORT ELIZABETH ON 17th APRIL 2003.**

- 1. Present and Apologies** – As noted in the attendance register (18 plus 7 apologies) Gerald (ZR2GB) from East London.
- 2. Welcome** – The Chairman, Beavan, welcomed the 18 members present. The poor attendance was possibly because of the start of the Easter Week-end tomorrow. A special welcome to Gerald ZR2GB of East London.
- 3. Acceptance of the previous minutes** – Proposed Clive (ZS2RT), Seconded Rory (ZS2BL)
- 4. Finance** – Treasurer, Clive, reported the finances in good shape (as usual), New batteries for the Governorskop repeater had been purchased. Subs for 2003/4 were coming in nicely. Books were being audited now.
- 5. Correspondence** –
In The usual crop of Club Newsletters and Subscription renewals. Letter stating our lease of the Lady's Slipper repeater site file was to be closed by NMMM, in absence of a reply to a letter we didn't receive. Beavan to FAX the writer on Tuesday 22 when the office re-opens after Easter.
Out: Nil
- 6. General.**
 - 6.1** The PEARS AGM will be held at St HUGHS Church hall on 17th May 2003 A boot sale will be held at approximately 15h00 The Main meeting at 16h00 and the braai fires available by 17h00. The Club will supply Ice Cream and White Wine.....members to bring the rest.
 - 6.2** Wrinkly Ravers venue possibly at Saddles or Cassies in Newton Park. Listen to Sunday Bull.
 - 6.3** Whoever has the **Clubs** 1997 ARRL Manual please return it to the club ASAP. (4th Request !)
 - 6.4** Members are reminded of the election of the Committee for 2003/4 year.. We need a candidate willing to take over the Chair and two others. Also to let the Chairman have any recommendations for PEARS awards for the past year **before** the AGM. Categories : DX Trophy, Constructors Trophy, Ham Spirit Award, PEARS Merit Trophy and An Achievement Award. Nomination slips were distributed for these awards at the meeting.
 - 6.5** Ken ZS2BWB will be speaking at the June meeting on various Digital Modes for which a new Microwave / Digital Mode Contest is being put together under the auspices of PEARS, with proposed starting date in June 2003. This will be run separately from the annual PEARS VHF/UHF contest.
 - 6.6** Chris ZS2AAW in spite of a heavy work overload, is working on a new system for the Governorskop site. Time and Equipment however is not easy to come by.
 - 6.7** Garth ZS2HB, gave us a rundown on the happenings at the SARL AGM in Bloemfontein and Gerald (ZR2GB) our East London Visitor, ran a presentation of photos taken at the AGM.

Nothing further to discuss the TEA Donation draw was made and won by Jim ZS2JF who donated his winnings to the club tea funds This arrangement has made the Tea/Coffee/Biscuit provision self supporting.

The meeting closed at 21h10. 📍

MICROWAVE & DIGITAL CONTEST RULES CHANGE

The PEARS contest rules published in last month's QSO have been amended:–
In **Categories**, below (1) Terrestrial, add **(2) EME – CW/FM/SSB**.
Under **Reports and Scoring**, EME stations are permitted to work any local or DX station via the moon, but the distance claimed shall be the grid square to grid square distance.
Under **Microwave Stations**, insert **or CW** after **analogue**.
The full rules have been published on our website as well as that of the SA Radio League. 📍

REV COUNTER / TACHOMETER FOR OLDER TOW CARS

from Cyril Hislop, ZR2H

More often than not, the older cars used by caravanners for towing have no rev counters to indicate when peak torque revolutions are reached whilst towing. I found this circuit in an 1976 ETI magazine. Kinda suits the cars we are talking about

Using the versatile NE555V timer, which has the ability to sink 200mA at 4.5 to 18v, a very accurate rev counter can easily be built on a bit of 0,1 pitch veroboard.

Pulses from the points are fed to a 1k resistor and a 5v zener for clamping and then trigger pin 2, which causes the output to go high on pin 3 for a duration set by the R/C ratio on pins 6 & 7.

During this time the 1N4148 on pin 3 is reversed biased, and the 4.7k resistor and the preset supply a constant current to the meter, which is calibrated in Rev/Min. The meter gives an analogue representation. When the time duration lapses, pin 3 goes low, shunting all current around the meter.

The ratio of current flow to the time

it is shunted gives a representation of RPM, which is integrated, (or smoothed) by the meters mechanical movement, to give a very accurate indication, when calibrated, of the RPM.

Accuracy is nominally to 2%.

The 9v zener, 15 ohm resistor and 10 μ F capacitor are to stabilize the current supply to the meter.

Calibration can be made using 50Hz 12v pulses derived from the domestic mains if it is remembered that the points operate at 2 times the engine RPM on a 4 cylinder engine, i.e. 50Hz = 3000 cycles per min for a 4 cylinder engine. On a 6 cylinder it's 1125 RPM.

The 555 IC gives temperature stability and solid state reliability. 

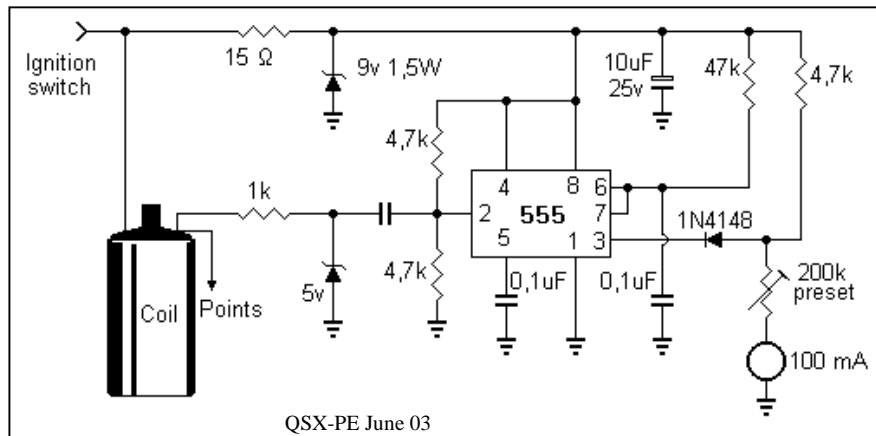

OUR AGM HAS COME AND GONE

About 60 people attended our AGM in May in spite of the rainy weather. There were some from Wilderness, East London, Cradock, Jeffrey's and Aston Bay, Bathurst, Grahamstown, Port Alfred and elsewhere. The usual gang was hanging around the bring-and-buy section and many bought some good stuff for their shacks.

The meeting proper started a fraction after 4 pm and, after the usual year-end reports were delivered, there was some discussion about Echolink with a description by Gerald ZR2GB. Thanks go to Richard ZS2CLI for arranging the Internet link in East London.

On Repeaters and Packet, Chris gave a run-down on the situation.

At this point, the Society's annual awards were presented, i.e.

Appreciation Certificates

Gus ZS2MC for auditing the Club's books

Martin ZR2MR for relaying the various news bulletins on CB Radio

Ewalt ZS2EHB and Rory ZS2BL for reading the SARL bulletin respectively in Afrikaans and English on Sundays

Ashley ZR2AG for printing QSX each month at cost

Achievement Certificate to Ken ZS2BWB for all band activity

Trophies

ZS2OB DX Trophy to Ken ZS2BWB

ZS2AB trophy to Al ZS2U for construction of antennas

Ham Spirit Trophy to Cyril ZR2H

Merit Award to Ewalt ZS2EHB for promotional work for Ham Radio

Special Award Cup to Chris ZS2AAW for outstanding work on the repeater network.

There were also the following awards presented:

Hamnet Shield for reliability: Des

ZS2ABU

SARL award for best historical article in Radio ZS: Mike ZS2FM

The blooming outgoing Chairman had forgotten the SARL certificate for Al ZS2U for his efforts in the PEARS National VHF/UHF contest.

We extend our congratulations to all these people on their fine achievements.

In the election of officers for the Society during 2003/4, Rory was nominated as chairman. (Let's hope *he* doesn't forget Al's certificate). There was one newcomer to the committee, Ashley ZR2AG, and the remaining members of the old committee who were available were re-elected, i.e. Bill ZS2ABZ, Chris ZS2AAW, Clive ZS2RT and Ewalt ZS2EHB.

The tea fund donations were drawn and won by Dirk ZS2D and Saney ZR1S, with a third of the takings going to the club.

At this point, Rory was duly installed and the blackboard eraser handed to him by the outgoing Chairman (yes, the outgoing Chairman had forgotten the gavel).

Rory thanked the past committee for their efforts and duly closed the meeting.

With rain still coming down outside, the two braai fires under cover of the garage lean-to did an excellent job. Those in the hall enjoyed themselves and had a good chat with all the fogies present.

Another good AGM had come and gone. ☐

From the AGM



Left – Martin Ras ZR2MR receives his certificate from the Chairman.

Centre – Chairman Rory receives the blackboard cleaner from OM Beavan,

Bottom (left) – Ashley gets his certificate.

(right) – Cyril looking into his mug for something wet and strong.



Pearstalk



NOTE: The Volkswagen rally is scheduled to be run on 18/19 July. Please get your stuff ready and let Chris Scarr know that you're available.

ASHLEY TO DO INTECNET RELAY

Ashley Goosen ZR2AG will undertake the relay of the next intecnet on 22 June. He will extend the telephone link onto the VHF network and relay questions on VHF back to control via the telephone.

AL WORKS NATAL ON 144 MHZ

Al Akers ZS2U worked ZS5DJ and then Lee ZS5LEE in Durban on two metres during April. Good going, Al.

CONGRATS TO CONTEST CHAPS

We find a couple of our members mentioned in the results of the PEARS VHF/UHF contest in January. Congrats to André and Garth for the longest distances on 432 MHz, having worked ZR2GB and ZS2KW. Then ZR2GJ/1 and ZS2AZR/1 won the Region One field station category on 144 MHz, while Ken ZS2BWB was second in both the 50 MHz fixed and 432 MHz fixed station categories.

SARL KID'S DAY

The next SARL Kid's Day will be on the air on Youth Day, Monday 16 June 2003. The activity will run from 09:00 to 11:00 SAST on the 20, 40 and 2 metre bands.

The aim of the Kid's Day is to encourage young people (licensed or not) to enjoy amateur radio. It can give young people hands-on, on-the-air

experience so they might develop an interest in pursuing a licence in the future.

Because the Comrades Marathon is being run the same day, the exchange will be name, age, location and favourite sportsman or sportswomen.

Operators are encouraged to allow the young people to talk to other young people around the country – do not limit it just to the exchange.

Show the young people some of the other modes of operating such as CW, SSTV, packet, PSK31, etc.

SARL PRESIDENT RESIGNS

At the opening of the special budget meeting which was held recently at the NARC, Vice President of the SARL, Hans Potgieter, ZS6ALJ, announced that Sid Tyler, ZS6AYC, resigned as President of the SARL as from 15 May.

Hans Potgieter will thus be at the helm of the SARL until the council meeting that will be held after the Special General Meeting on 21 June 2003. This meeting will deal with the amended budget for 2003/2004.

A new President will be elected during that council meeting.

136 kHz BAND CONTACT

The first GM to YU contact on the 136 kHz band has been reported. Simon Lewis GM4PLM completed the first Scotland to Yugoslavia LF contact

at 22:28 UTC on 20 April. Simon had a two-way contact with Teo YU7AR on 137.7 kHz.

Simon was using equipment left behind by David Bowman G0MRF, when the UK 73 kHz record was broken.

EAST TIMOR OFF THE AIR

The ITU's prefix assignment 4WA-4WZ was intended for the use of United Nations Temporary Administration of East Timor (UNTAET) as long as it existed, and was to be released to the ITU at the end of its existence.

The UNTAET organization's charter in East Timor expired on 20 May, 2002, and all ham radio operating authority also expired on that date.

The East Timor government is expected to take over responsibility for ham radio licensing, but for the time being it appears that East Timor is off the air.

For DXCC purposes, UN Temporary Administration of East Timor was added to the DXCC List with the effective date of 1 March 2000

ALL 6 ZS DIVISIONS ON 2 m

Congratulations to ZS4NS, who might be the first ZS station to work all divisions on 2 m. The final contact was established with ZR1AEE on Tuesday at 20:20.

The SARL would like to know whether this achievement is indeed the first station to have worked all ZS divisions on 2 m.

EXTRAORDINARY 40m QSO

On Saturday, 3 May 2003, Nico ZS2N (Aliwal North) and Johan ZS1I (Mossel Bay) established an unscheduled contact on 7 050 kHz at 15:30.

After 30 minutes of talking they were joined by Stefan ZS3S (Carnarvon), Herman ZS6HLJ (Carletonville), Nico

ZS4NE (Bloemfontein), Pieter ZS4PB (Vryburg) and David ZS1LDH (Cape Town).

It was discovered that a Division 5 station was needed to ensure a QSO of all divisions. Vic ZS5UN from Hillcrest joined shortly afterwards which resulted in the establishment of a contact between all divisions in the country, purely by coincidence.

NEW IRLP LINK ACTIVATED IN PRETORIA

The Quantum Amateur Radio Club is commissioning a new IRLP link in Pretoria. The node is in the final testing stage and hams are encouraged to try it.

70 MHz/4m ACTIVITY IN PRETORIA

In the Pretoria area, there is quite an amount of activity on the recently allocated 70 MHz, or 4 m band. There are quite regular QSO's on 70,200 MHz in the evenings.

On Sundays at 10:00, ARMI and the Magalies Radio Amateur Club's bulletin at 11:15 are being relayed on 70,200 MHz by Pieter ZS6PVW. These relays have already been heard in Randburg and as far as Cullinan.

Please remember that if you hear strangers on the band, they have preference, since the 4 m band is allocated to us on a secondary basis.

[I don't believe anybody was told that the band had now been handed to us. Previously only a small segment was allocated. – Ed]

DXPEDITION TO SWAZILAND

Rad ZS6RAD, Ron ZS5ABD, Cliff ZS6BOX, Nigel 3DA0NG and Willie ZS5WI will be operating from Ezulwini, Swaziland from 29th July to 3rd August 2003. They will be joined by Willie 3DA0BD and Andy 3DA0TM as time permits

Activity will be on most bands – possibly including VHF – probably using phone, CW, WSJT and RTTY from 03h00 to 07h00 and from 14h00 to 22h00 UTC daily.

They will be participating as a multi-operator station during the SARL phone contest.

QSL via the bureau or direct to ZS5WI, PO Box 1064, Eshowe, 3815, KZN, South Africa enclosing a SASE.

LOGBOOK OF THE WORLD

The long-anticipated "Logbook of the World" (LoTW) – the ARRL's secure electronic contact-confirmation system – is being opened for beta testing.

At the heart of the Logbook of the World concept is a huge repository of log data provided by operators – from individual DXers and contesters to major DXpeditions – and maintained by the ARRL.

The system will provide quick QSO credit for awards offered by the ARRL – and, it's hoped, those offered by other organizations as well – without having to first collect and submit hard-copy QSL cards.

It is not the intention to replace the whole paper QSL scheme with Logbook of the World. This is really a system to

offer credits for awards.

e-MAILS RADIO ACCESSORIES & DATA MODEMS, JHBURG

Radio Accessories & Data Modems, who support Radio ZS with a two-page advert, have quite a bit of new and used equipment for sale. As far as the used equipment is concerned, you can e-mail the company at radioacc@global.co.za for details

LESOTHO UPDATE

A sixth operator has joined the July weeklong Lesotho DXpedition. That will give the group even more expertise on CW and digital mode operations. The newest operator to join the group is Igor Zdorov W0IZ of Minneapolis, MN.

Look for 7P8CF and 7P8TA to be the main phone operators, while 7P8MJ, 7P8NK, 7P8DA and 7P8IZ will be mostly CW and digital modes. They are

7P8CF – K5LBU Frosty

7P8NK – VA7DX Neil

7P8TA – WW5L Tom

7P9DA -K4SV Dave

7P8IZ – W0IZ Igor

7P8MJ – W5MJ Madison

QSL each call individually since there won't be a main DXpedition call sign. 

PROXY FORM FOR SPECIAL GENERAL MEETING ON 21 JUNE

(Please complete and post to R. Seddon, 2 Slabbert Street, Summerpride, East London or to the SARL, PO Box 1721, Strubensvallei 1735 or fax 011 675 2793 not later than noon on 19 June)

I, callsign, a paid-up member of the SA Radio League, hereby appoint Mr. Richard Seddon ZS2CLI to vote on my behalf at the special general meeting to be held on 21 June and at any postponement thereof.

Signature

Date _____

Condolences – We learned with great sadness of the passing on 12 May of the XYL of Louis Jordaan, ZR2J. She had been ill for quite some time. We extend our sympathy to you and all the other members of the family, Louis.

And to those celebrating special days we say

Have a Happy Day...



...on your birthdays:

June

23 Denny Davies, XYL of ZSL037
28 Pieter Liebenberg ZS2PL
28 Ken Tremeer ZS2BWB

12 Joan & George Bowes ZS2QN
13 Janet & Ashley Goosen ZR2AG
15 Magret & Martin Ras ZR2MR
19 Charmaine & Selwyn Whitebooi
ZR2KAT

July

1 Brett Tapson
3 Julie Scarr ZR2EY
5 Nico Oelofse ZS2N
6 Martin Venter ZS6AZV
7 Jim van Loggerenberg ZS2LR
9 Janet Goosen, XYL of ZR2AG
11 Isaac Greeff ZS2ZG
13 Cyril Hislop ZR2H
19 Bill Browne ZS2BY
19 Arthur Baynes ZR2ARB

Congratulations

on your new licences Jaco Barkhuizen, ZR2B, Arthur Glaum ZR2APG and Paul van der Merwe, ZR2PJ. We hope you will enjoy your new hobby.



Other news ...

...on your anniversaries



June

24 Blanka & Vic Batt
ZR2BBH
24 Ali & Ewan Mathieson ZS1EM

July

2 Sally & Donald Jacobs ZS2BW
4 Marge ZS2OB & Brian Weller
ZS2AB
12 Julia & Will Atteridge ZS2V
12 Liz & Allen Lubbe ZS2AEG

New members: Clive and Edna Swanepoel, of Uitenhage. We're sure you will find your new Society to your liking, you two.

Travelling: Shirley and Gus ZS2MC are due back from Johannesburg, where they visited their daughter for her 21st birthday.

Greetings from Greg ZS2RE and Morag Maynard, who are settled temporarily in the UK. They are both working, but also plan to see a lot of the UK and various parts of the Continent. 📍

Your Society's Committee

Chairman, Awards.....	Rory Norton ZS2BL	585-9330	rory@commco.co.za
Vice Chair,	Undetermined		
Secretary, repeaters, packet,	Chris Scarr ZS2AAW	368-1344	cvscarr@intekom.co.za
Treasurer; Assets Control.....	Clive Fife ZS2RT	367-3203	cfife@freemail.absa.co.za
Social, Refreshments,	Bill Hodges ZS2ABZ	581-2580	whodges@absamail.co.za
Special Events	Ewalt Bouwer ZS2EHB	933-3482	ewalt.b@freemail.absa.co.za
QSX printing and info.....	Ashley Goosen ZR2AG	372 2052	ashleyg@mweb.co.za
Internet Website (ex com).....	Barry Murrell ZR2DX	083 717 9210	zr6dxb@qsl.net
Technical Classes (ex com)....	Al Akers ZS2U	360-2983	
QSX Editor (ex com).....	Garth Laaks ZS2HB	368-1101	glaaks@iafrica.com
QSX distribution (ex com)....	Trevor Scarr ZS2AE	367-1746	t&j.scarr@intekom.co.za

PEARS' VHF/UHF & Other Services

REPEATERS

Town VHF	# 145,050/650	
Town UHF	# 431,050/438,650	Knysna
Cockscomb	145,000/600	Lady's Slipper.....
Colesberg	* 431,075/438,675	Noupoort.....
Cradock	* 145,050/650	Uitenhage.....
Grahamstown	* 145,150/750	

* These form the PEARS long-range 2-metre repeater system, also linked to which are East London 145,775 MHz, George 145,700, Danabaai 145,600, Stilbaai 145,750, Butterworth 145,725, King Williams Town 145,625 and Umtata (438,725 duplex). It is further extendable to Cape Town via the WCRWG system. # These can also be linked as required.

OTHER SERVICES

Packet Bulletin Board (ZSØNTP)	144,625
Packet Rose Switch ZSØGHT-3,046101 (144,675 in/out) or 046102 (UHF out to BBS).....	144,675
2m Beacon (ZS2VHF CW ID, FSK) (horizontally polarized, 160W ERP,)	144,415
6m Beacon (ZS2SIX CW ID) (horizontally polarized, 25W ERP)	50,005
6m Simplex Link with Lady's Slipper 2m Repeater (vertically polarized)	51,400
Wefax Relay (Meteosat).....	145,350

Sunday Bulletins

PEARS bulletins are transmitted on Sundays immediately after the SARL English transmission, i.e. at about 08:45, on 7098 kHz as well as the 2 metre linked network that provides coverage from East London to George as well as Cradock and environs. PEARS' 7098 or 3640 kHz transceive facilities are also remotely linked as needed. In addition, the SARL's 40m operations on 7082 or 7066 kHz or Hamnet's 7070 kHz can be remotely patched into the 2m network, in receive-only mode or with full transceive capability for interactive events.

Date	Prepare and Read on 2m Repeater Link
15 June	ZR2AG
22	ZS2ABZ
29	ZS2BL
6 July	ZS2EHB
13	ZS2AAW
20	ZS2RT

DIARY DATES
JUNE
19 PEARS general meeting; bring and buy
13-15 PEARS M/wave & Digital 'test
JULY
1 SARL subscriptions due
3 Wrinkley Rave

* We like being your Society *